

SHAFT LAYOUT

Small Machine Room Passenger Elevator

Small machine room passenger elevator adopts compact host and narrow control cabinet, which can greatly reduce the machine room area, and take advantage of the space of original machine room effectively, so that the elevator and architectural design will be integrated.

Low noise operation: driven by no gear traction machine, no vibration, low noise, to create a sophisticated environment

Lightweight appearance: only a small machine room space is needed, which can be freely placed around the shaftway and use valuable building space freely.

Energy saving and environmental protection: multiple energy-saving technologies and devices are used, and the energy saving can up to 60%.



No Vibration

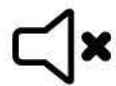

Low Noise



Machine Roomless Passenger Elevator

Machine roomless passenger elevator breaks the inherent mode of installing a machine room, the compact host and narrow control cabinet are directly place on the shaftway, so as to provide a larger lift car and a spacious environment in the same shaftway. At the same time, the building design will be given with the greatest freedom, the space utilization and building use efficiency will also be greatly enhanced.

Sophisticated quality: compact structural design and excellent new materials are used to provide rich design options, and achieve the perfect combination of appearance and function.

Economical and practical: the shaftway is all needed to complete the overall installation, and effectively reduce the cost of building space.

Light and flexible: machine roomless elevator is more compact than the traditional elevator, which is more flexible to integrate into the building.



Small Space



Select More



MOTOR

Permanent Magnet Synchronous And Gearless Traction Machine

It uses rare earth materials, fully integrates coaxial transmission technology, digital frequency technology with group computer control technology, high-efficient and energy-saving, with minimum operation cost, low heat loss, and extremely high efficiency, can save up to 40% energy compared with general traditional technology. Besides, by using gearless traction machine doesn't need changing grease, no oil contamination, low noise design, creating a quiet riding space for you.

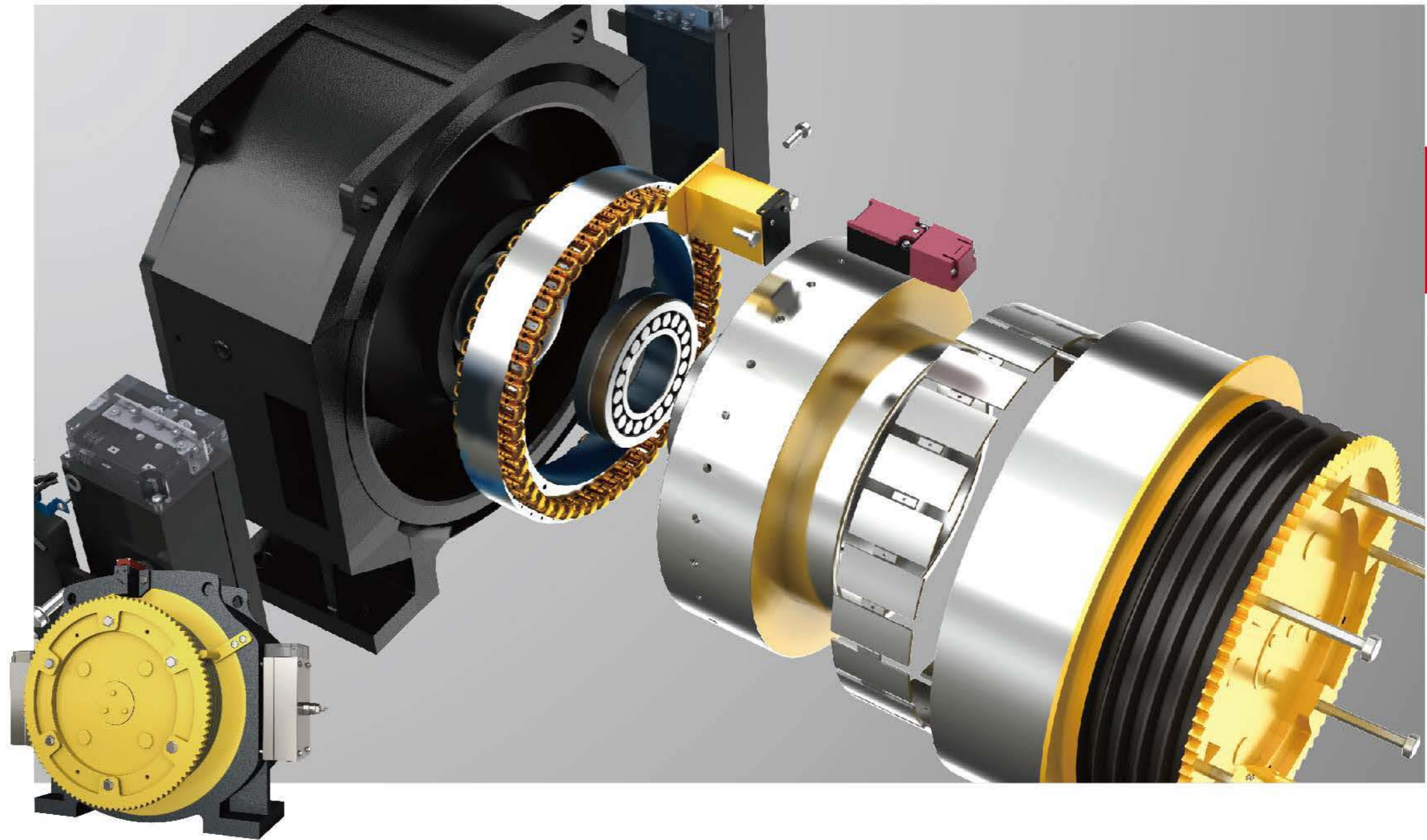

VVVF New Controller

It can automatically adjust the current and precisely control the torque of the host machine according to the load of the car, fully making the elevator stable and comfortable.

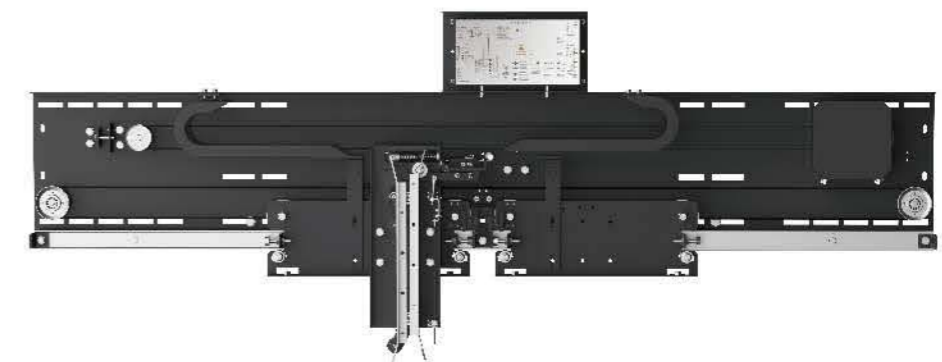

Door System

The application of advanced VVVF control technology into elevator door machine system ensures the smooth and quiet door opening and closing, increases the sensitivity of elevator door opening and closing, and automatically adjusts the most appropriate opening and closing speed for each landing, ensures safety and reliability. Besides, the door load detector with self-learning ability can better improve the sensitivity of door opening and closing, monitor the changes of door load for each floor, and can reopen the elevator door automatically in case of abnormal resistance.

STANDARD HAIRLINE STAINLESS STEEL CONFIGURATION



OT-P01

Ceiling: Luxury mirror stainless steel, LED light decoration
 Car wall: Hairline stainless steel
 Car door: Hairline stainless steel
 Car floor: PVC
 COP: Hairline stainless steel
 LOP: Hairline stainless steel panel



OT-C01

Luxury mirror stainless steel, LED light decoration



OT-F01

PVC/Marble



OT-D01

Hairline stainless steel



OT-COP01



OT-LOP01

STANDARD TITANIUM GOLDEN CONFIGURATION



OT-P02

Ceiling: Soft lighting design of broad arched white light-emitting panel golden type
 Side walls and rear wall:
 Central panel: Golden etched mirror stainless steel
 Auxiliary panels: Golden etched hairline stainless steel
 Handrail: Combination of round wood and titanium gold
 Floor: PVC/Marble

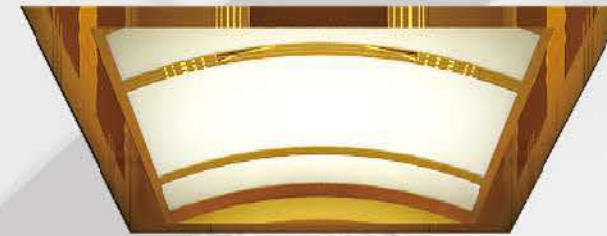

OT-C02

Soft lighting design of broad arched white light-emitting panel golden type



OT-F02

PVC/Marble



OT-D02

Golden etched mirror stainless steel



OT-COP02



OT-LOP02-1



OT-LOP02-2

OPTIONAL PASSENGER ELEVATOR CAR DECORATION



OT-P03

Ceiling: Mirror stainless steel with LED lights
 Car Wall:
 Central panel: Etched mirror stainless steel
 Auxiliary Panel: Hairline stainless steel
 Handrail: Hairline stainless steel
 Floor: PVC/Marble



OT-P06

Ceiling: Hairline stainless steel frame, acrylic lighting
 Rear wall: Etched gold stainless steel, Mirror stainless steel
 Side wall: Hairline stainless steel
 Handrail: Stainless steel single round handrail
 Floor: PVC/Marble

OT-P04

Ceiling: Hairline, acrylics silk-screen printing
 Rear wall: Mirror stainless steel, Hairline stainless steel
 Side wall: Mirror stainless steel, Hairline stainless steel
 Handrail: Hairline stainless steel
 Floor: PVC/Marble



OT-P07

Ceiling: Stainless steel with acrylic light panel
 Car wall:
 Central panel: Mirror stainless steel
 Auxiliary Panel: Etched mirror stainless steel
 Floor: PVC/Marble



OT-P05

Ceiling: Mirror stainless steel
 Car wall: Hairline stainless steel, mirror, etching
 Handrail: Stainless steel tube
 Floor: PVC/Marble



OT-P08

Ceiling: Mirror stainless steel frame, acrylic
 Car wall:
 Central panel: Hairline stainless steel
 Auxiliary Panel: Etched mirror stainless steel
 Floor: PVC/Marble

2500 Lb
 1134 Kg
 Elevator
 15 PERSONS

OPTIONAL PASSENGER ELEVATOR CAR DECORATION



OT-P09

Ceiling: Titanium stainless steel frame, acrylic decorative lighting panels
 Car wall: Titanium mirror etched stainless steel
 Floor: PVC/Marble

OT-P10

Ceiling: Titanium stainless steel frame, acrylic decorative lighting panels, downlights embellishment in the middle
 Car wall:
 Central panel: Titanium gold etched mirror stainless steel
 Auxiliary Panel: Titanium gold hairline stainless steel
 Floor: PVC/Marble



OT-P11

Ceiling: Stainless steel mirror hollowed-out plate, white light-emitting board match with aluminum alloy frame
 Car wall:
 Central panel: Titanium gold etched mirror stainless steel
 Auxiliary Panel: Titanium gold mirror stainless steel
 Handrail: Titanium gold stainless steel three-tube
 Floor: PVC/Marble

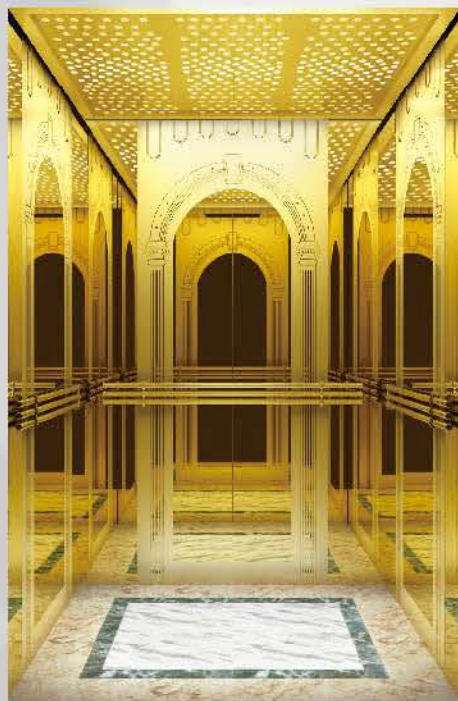

OT-P12

Ceiling: Rose gold mirror stainless steel, LED light decoration
 Car wall: Rose gold etched stainless steel
 COP: Luxury front-wall integration type
 Floor: PVC/Marble

OT-P13

Ceiling: painted steel plate, acrylic
 Car wall:
 Central panel: Etched mirror stainless steel
 Auxiliary panel: Rose gold hairline stainless steel
 Floor: PVC/Marble



OT-P14

Ceiling: Rose gold hairline stainless steel, ceiling frame, central LED lighting.
 Car rear wall: Mirror stainless steel
 Car side wall: Rose gold stainless steel
 Floor: PVC/Marble



2500 Lb
 1134 Kg
 15 PERSONS
 Elevator

OPTIONAL PASSENGER ELEVATOR CAR DECORATION



OT-P15

Ceiling: Titanium mirror stainless steel organic lamp post
 Side walls and rear wall: Mirror, etching, hairline and gold recessed parts (center panel hairline (auxiliary plate)
 Handrail: Stainless steel double-tube handrail
 Floor: PVC/Marble



OT-P18

Ceiling: Mirror stainless steel frame, acrylic light-passing board, four sides downlight
 Car wall:
 Central panel: Wooden stainless steel
 Auxiliary Panel: Mirror stainless steel
 Handrail: Wooden & Mirror stainless steel
 Floor: PVC/Marble

OT-P16

Ceiling: Champagne gold stainless steel frame, acrylic decorative lighting panels, down lamps embellishment in the middle
 Car wall: Champagne gold stainless steel with champagne gold mirror etched stainless steel combination
 Floor: PVC/Marble



OT-P19

Ceiling: Titanium black stainless steel frame, acrylic light-passing board
 Car Wall: Titanium black mirror stainless steel, wooden stainless steel
 Handrail: Titanium black mirror stainless steel, flat handrail
 Floor: PVC/Marble



OT-P17

Ceiling: Titanium mirror stainless steel, ceiling lamp in the middle, down lamp around
 Car Rear Wall: Titanium mirror stainless steel with light marble
 Car side Wall: Etched titanium mirror stainless steel with light marble
 Handrail: Wooden steel with titanium stainless steel
 Floor: PVC/Marble



OT-P20

Ceiling: Mirror stainless steel frame, acrylic light-passing board
 Car wall:
 Central panel: Mirror stainless steel
 Auxiliary Panel: Wooden stainless steel
 Floor: PVC/Marble

2500 Lb
 1134 Kg
 15 PERSONS
 Elevator

OPTIONAL PASSENGER ELEVATOR CAR DECORATION



OT-P21

Ceiling: Mirror stainless steel with LED lights
 Car Real Wall: Mirror with Hairline stainless steel
 Car Side Wall: Hairline stainless steel
 Floor: PVC/Marble

OT-P22

Ceiling: Mirror stainless steel with LED lights
 Car Real Wall: Mirror with hairline stainless steel
 Car Side Wall: Hairline stainless steel
 Floor: PVC/Marble



OT-P23

Ceiling: Mirror stainless steel with LED lights
 Car Wall: Central Panel: Etched mirror stainless steel
 Auxiliary Panel: Hairline stainless steel
 Floor: PVC/Marble



OT-P24

Ceiling: Golden mirror stainless steel with LED lights
 Car Wall: Central Panel: Golden mirror stainless steel
 Auxiliary Panel: Golden hairline stainless steel
 Handrail: Golden hairline stainless steel
 Floor: PVC/Marble

OT-P25

Ceiling: Golden Golden Mirror stainless steel with LED lights
 Car Wall: Central Panel: Golden etched mirror stainless steel
 Auxiliary Panel: Golden mirror stainless steel
 Floor: PVC/Marble



OT-P26

Ceiling: Golden Mirror stainless steel with LED lights
 Car Wall: Central Panel: Golden etched mirror stainless steel
 Auxiliary Panel: Golden hairline stainless steel
 Floor: PVC/Marble



2500 Lb
 1134 Kg
 15 PERSONS
 Elevator

OPTIONAL PASSENGER ELEVATOR CAR DECORATION



OT-P27

Ceiling:Rose golden mirror stainless steel with LED lights
 Car Wall:
 Central Panel:Rose golden etched mirror stainless steel
 Auxiliary Panel:Rose golden mirror stainless steel
 Handrail:Rose golden stainless steel flat handrail
 Floor:PVC/Marble

OT-P28

Ceiling:Rose golden mirror stainless steel with LED lights
 Car Wall:
 Central Panel:Rose golden etched mirror stainless steel
 Auxiliary Panel:Rose golden hairline stainless steel
 Floor:PVC/Marble



OT-P29

Ceiling:Rose golden mirror stainless steel with LED lights
 Car Wall:Central Panel:Rose golden etched mirror stainless steel
 Auxiliary Panel:Rose golden mirror stainless steel
 Floor:PVC/Marble



OT-P30

Ceiling:Black mirror stainless steel with LED lights
 Car Wall:
 Central Panel: Etched mirror stainless steel
 Auxiliary Panel:Black mirror stainless steel
 Handrail:Hairline with black mirror stainless steel
 Floor:PVC/Marble

OT-P31

Ceiling: Champaign golden mirror stainless steel with LED lights
 Car Wall:
 Central panel: Champaign golden etched mirror stainless steel
 Auxiliary panel: Champaign golden mirror stainless steel
 Floor:PVC/Marble



OT-P32

Ceiling:Hairline stainless steel with LED lights
 Car wall:
 Central Panel: Rose golden etched mirror stainless steel
 Auxiliary panel:Hairline stainless steel
 Handrail: Rose golden with wooden stainless steel
 Floor:PVC/Marble

2500 Lb
 1134 Kg
 Elevator

OPTIONAL PASSENGER ELEVATOR CAR DECORATION



OT-P33

Ceiling: Mirror stainless steel with LED lights
 Car wall:
 Central panel: Mirror stainless steel
 Auxiliary panel: Wooden stainless steel
 Handrail: Mirror with wooden stainless steel on two sides
 Floor: PVC/Marble

OT-P34

Ceiling: Mirror stainless steel with LED lights
 Car wall:
 Central panel: Etched mirror stainless steel
 Auxiliary panel: Wooden stainless steel
 Handrail: Mirror with wooden stainless steel on three sides
 Floor: PVC/Marble



OT-P35

Ceiling: Mirror stainless steel with LED lights
 Car Wall:
 Central panel: Mirror stainless steel
 Auxiliary panel: Wooden stainless steel
 Floor: PVC/Marble



OPTIONAL PANORAMIC ELEVATOR CAR DECORATION



OT-G01

Car cover: Painted steel plate, acrylic lighting decoration
 Observation wall: Square, glue glass of safety clamp
 Decoration roof: Stainless steel mirror base plate is supplemented with golden down lamp and car wall, soft lighting design of arched white transparent board in the middle
 Car wall: Hairline stainless steel
 Handrail: Stainless steel tube
 Floor: PVC/Marble

OT-G02

Car cover: Painted steel plate, decoration lamp
 Observation wall: Glue glass of safety clamp
 Decoration roof: Stainless steel mirror base plate is supplemented with golden down lamp and car wall, soft lighting design of arched white transparent board in the middle
 Car wall: Hairline stainless steel
 Handrail: Stainless steel tube
 Floor: PVC/Marble



OT-G03

Car cover: Painted steel plate, decoration lamp
 Observation wall: Glue glass of safety clamp
 Decoration roof: Stainless steel mirror base plate is supplemented with golden down lamp and car wall, soft lighting design of arched white transparent board in the middle
 Car wall: Hairline stainless steel
 Handrail: Stainless steel tube
 Floor: PVC/Marble



2500 LB
 1134 kg
 15 PERSONS
 Elevator

OPTIONAL PANORAMIC ELEVATOR CAR DECORATION



OT-G04

Car cover: Steel plate baking finish
 Observation wall: Laminated glass
 Decoration roof: Central image arch, stainless steel base plate is supplemented with soft lighting design of down lamp at both sides
 Car wall: Hairline stainless steel
 Handrail: Stainless steel pair tube
 Floor: PVC/Marble

OT-G05

Car cover: Painted steel plate plus color decoration patterns
 Observation: 3 PCS of safety laminated glass
 Decoration roof: Middle with white roof lamp around stainless steel floor with tube lamp for soft illumination design
 Car wall: Hairline, etched
 Handrail: Stainless steel tube
 Floor: PVC/Marble



OT-G06

Car cover: Steel plate baked enamel, stainless steel skirting, decoration lamp
 Observation: 3PCS of safety laminated glass
 Decoration roof: Circle board mode back with tube lamp for soft illumination design
 Car wall: Hairline plate, etched
 Handrail: Stainless steel tube
 Floor: PVC/Marble



OT-G07

Car cover: Half-round acrylic crown, outer metal hood, stainless steel skirting
 Observation: 3PCS of safety laminated glass
 Decoration roof: Round steel strip model, white organic panel, down lamp
 Car wall: Hairline plate, mirror, etched, titanium gold
 Handrail: Stainless steel tube
 Floor: PVC/Marble

OT-G08

Car cover: Painted steel plate, acrylic ball cover
 Observation: 3PCS of safety laminated glass
 Decoration roof: Water lily pattern for circle board, back with tube lamp soft illumination design
 Car wall: Stainless steel hairline plate
 Handrail: Stainless steel tube
 Floor: PVC/Marble



OT-G09

Ceiling cover: Painted steel plate, decoration lamp
 Observation: Glue glass of safety clamp
 Decoration roof: Acrylic top panel, down lamp
 Car wall: Hairline stainless steel
 Handrail: Stainless steel tube
 Floor: PVC/Marble



OPTIONAL PANORAMIC ELEVATOR CAR DECORATION



OT-G10

Car cover: Staircase pentagon baked enamel steel plate, decoration lamp
 Observation: Glue glass of safety clamp
 Decoration roof: Central round acrylic ceiling lamp, down lamp
 Car wall: Stainless steel hairline plate
 Handrail: Stainless steel tube
 Floor: PVC/Marble

OT-G11

Decoration roof: Mirror stainless steel, downlight
 Car wall: 6+6 laminated safety glass
 Car cover: Hairline stainless steel
 Handrail: Hairline stainless steel
 Floor: PVC/Marble



OT-G12

Upper / lower hood: White acrylic
 Observation wall: 3 PCS of laminated glass
 Decoration ceiling: Steel plate plastic, tube lamp
 Car wall: Hairline stainless steel
 Handrail: $\Phi 38$ stainless steel tube
 Floor: PVC/Marble



OT-G13

Car cover: bake painted steel, acrylic lighting decoration
 Observation wall: laminated glass, 5+5mm
 Decoration roof: hairline stainless steel frame, creamy white lampshade, long lettuce lighting in the middle
 Car wall: laminated glass
 Handrail: $\Phi 38$ stainless steel pipe
 Floor: PVC

OT-G14

Upper and lower covers: sprayed steel plate
 Sightseeing wall: safety laminated glass
 Ceiling: lighting design of multi-layer reflective panels supplemented by waist shaped light transmission lamps and organic lamp columns
 Car wall: safety laminated glass
 Handrail: stainless steel single pipe
 Floor: PVC floor



OT-G15

Upper / lower hood: Baked ename finished steel, tube lamp
 Observation wall: Laminated glass (6+6)
 Decorative ceiling: Baked ename finished steel, acrylic crown plate, acrylic lighting
 Car wall: Hairline stainless steel
 Handrail: $\Phi 25.4$ stainless steel double-tubes
 Floor: PVC

OPTIONAL HOME ELEVATOR CAR DECORATION



OT-V01

Ceiling: Mirror stainless steel, acrylic transparent plate , LED light
 Car rear wall: Central panel: Etched mirror stainless steel
 Auxiliary Panel: Hairline stainless steel
 Side Wall: Central panel: Mirror stainless steel
 Auxiliary Panel: Hairline stainless steel
 Handrail: stainless steel round handrail
 Floor: PVC/Marble



OT-V04

Ceiling: Rose gold stainless steel, LED lights
 Central panel: Rose gold etched mirror stainless steel
 Auxiliary Panel: Wooden stainless steel
 Floor: PVC/Marble

OT-V02

Ceiling: Spay steel plate, acrylic, LED down lights
 Car rear wall: Central panel: Etched mirror stainless steel
 Auxiliary Panel: Wooden stainless steel
 Side Wall: Central panel: Mirror stainless steel
 Auxiliary Panel: Wooden stainless steel
 Handrail: Mirror stainless steel
 Car bottom: PVC/Marble



OT-V03

Ceiling: Champaign golden mirror stainless steel with LED lights
 Rear car wall: Champaign golden etched mirror stainless steel
 Side car wall: Champaign golden hairline stainless steel
 Handrail: Champaign golden with wooden stainless steel
 Floor: PVC/Marble

OT-V05

Ceiling: Mirror stainless steel, acrylic transparent plate, LED light
 Car wall: Hairline stainless steel frame, transparent glass wall
 Handrail: Stainless steel flat handrail
 Floor: PVC/Marble



OT-V06

Ceiling: Stainless steel mirror, corss-flow fan, LED white light
 Car walls: Left car wall, Imported wooden-color steel plate with full-wall operation panel, right and rear car walls - 6*6mm safety glass
 Handrail: Mirror stainless steel round handrail
 Floor: PVC/Marble



OPTIONAL COP



OT-COP-03



OT-LOP-03



OT-COP-04



OT-LOP-04



OT-COP-05



OT-LOP-05



OT-COP-06



OT-LOP-06-1



OT-LOP-06-2



OT-COP-07



OT-LOP-07

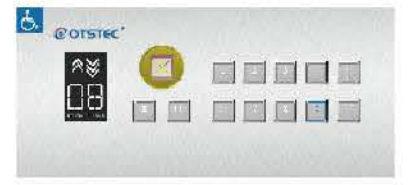

OT-COP-08



OT-COP-09

ARRIVAL GONG



OT-A-01 OT-A-02 OT-A-03

LCD



LCD-01



LCD-02

OPTIONAL LANDING DOORS



OT-D03
Mirror etched stainless steel

OT-D04
Mirror etched stainless steel

OT-D05
Mirror, etching



OT-D09
Mirror, etching

OT-D10
Rose gold, mirror etching finish

OT-D11
Mirror, glass



OT-D06
Mirror, etching

OT-D07
Mirror, etching

OT-D08
Mirror, etching, titanium



OT-D12
Titanium, mirror, etching

OT-D13
Titanium, mirror, etching

OT-D14
Titanium, mirror etching,
glass finish

OPTIONAL LANDING DOORS



OT-D15
Mirror, etching

OT-D16
Mirror, etching

OT-D17
Glass



OT-D18
Golden, mirror, etching

OT-D19
Golden, mirror, etching

OT-D20
Rose golden, mirror, etching

OPTIONAL CEILING

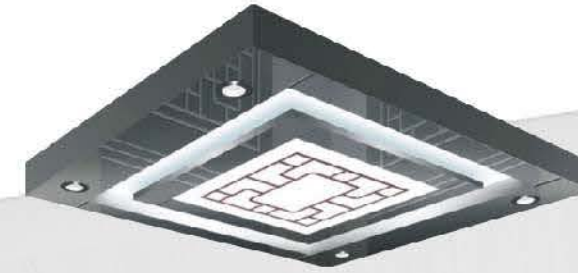

OT-C03
Stainless steel frame, square light board with LED light



OT-C04
Stainless steel frame, arched top plate with soft light design

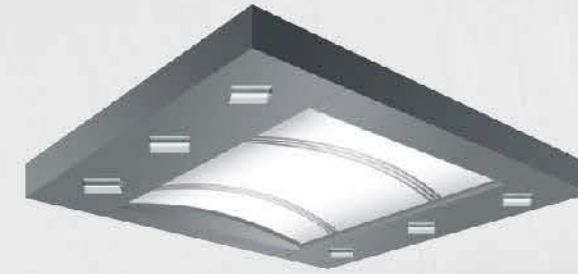

OT-C05
Mirror stainless steel frame, cylindrical light-passing lamppost with arched top plate



OT-C06
Arched top plate, stainless steel with LED light

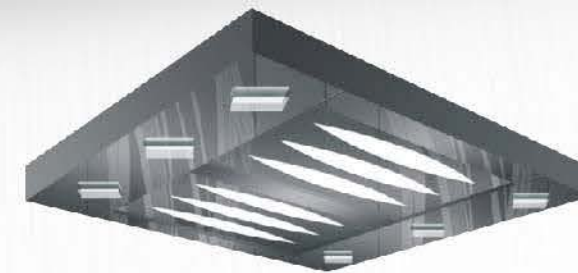

OT-C07
Stainless steel frame with acrylic light passing board



OT-C08
Stainless steel frame, geometric patterns with LED light

OPTIONAL CEILING



OT-C09

Steel plate, LED lighting

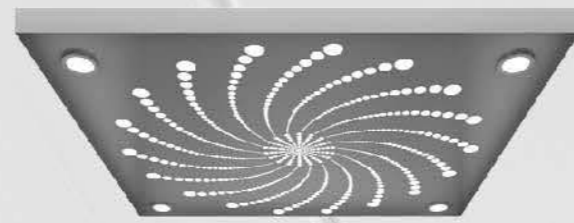

OT-C10

Mirror stainless steel, LED lighting



OT-C15

Hairline stainless steel frame,
acrylic top plate, down lamp



OT-C16

Painted steel framework,
arched top plate in the middle, down lamp



OT-C11

Stainless steel frame, white and soft lightening

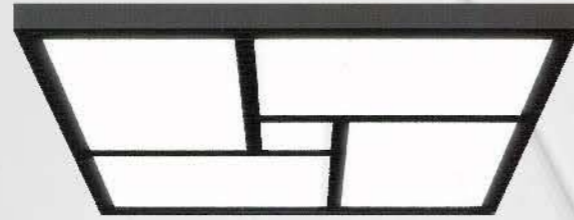

OT-C12

Mirror surfaced stainless steel made frame,
acrylic soft light illumination design

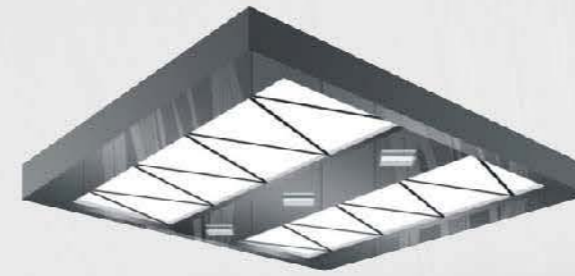

OT-C17

Stainless steel frame with acrylic light passing board



OT-C18

Hairline stainless steel frame,
acrylic transparency, energy saving lamp



OT-C13

Arched top plate, stainless steel with LED light



OT-C14

Pierced mirror surfaced stainless steel made frame,
acrylic soft light illumination design in the middle



OT-C19

Stainless steel frame with acrylic light passing board



OT-C20

Stainless steel frame, Mirror stainless steel with
white light-passing plate

OPTIONAL CEILINGS

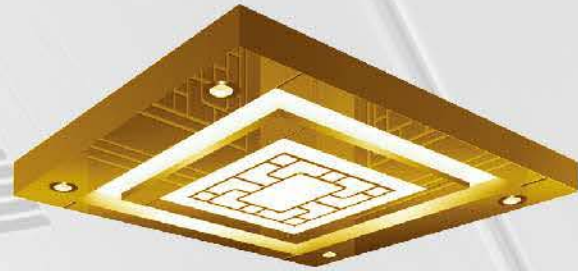

OT-C15

Titanium mirror stainless steel frame, acrylic transparent board, downlight

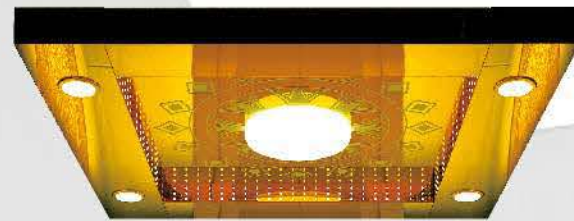

OT-C16

Titanium mirror stainless steel frame, acrylic transparent board, downlight



OT-C17

Titanium mirror stainless steel frame, acrylic transparent board, downlight



OT-C18

Mirror surfaced stainless steel made frame, down lamp around, light belt



OT-C19

Soft lighting design of circular plate and the rear of the lotus pattern process with LED lamp



OT-C20

The central white dome, surrounded by soft illumination design in stainless steel plate LED lamp

OPTIONAL DECORATION

Floor Series



OT-F01



OT-F02

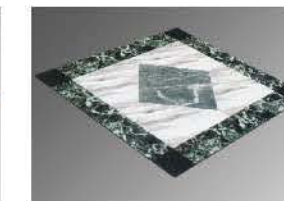

OT-F03

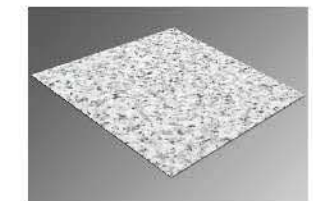

OT-F04

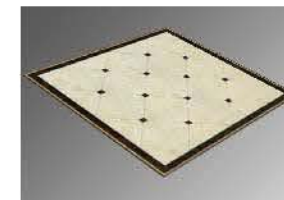

OT-F05



OT-F06



OT-F07



OT-F08

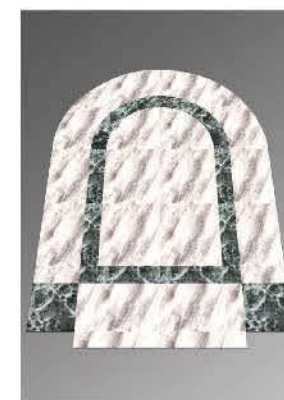

OT-F09



OT-F10



OT-F11



OT-F12

**OPTIONAL
HANDRAIL**



OT-H01



OT-H02



OT-H03



OT-H04

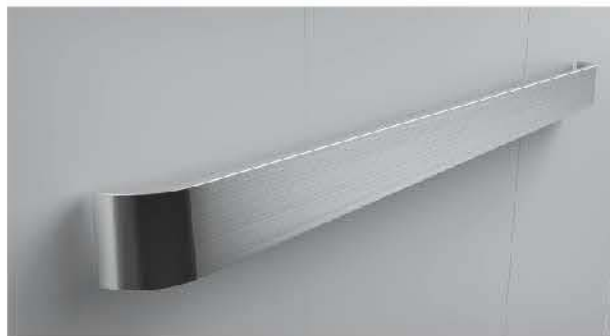

OT-H05



OT-H06



OT-H07



OT-H08



OT-H09



OT-H10

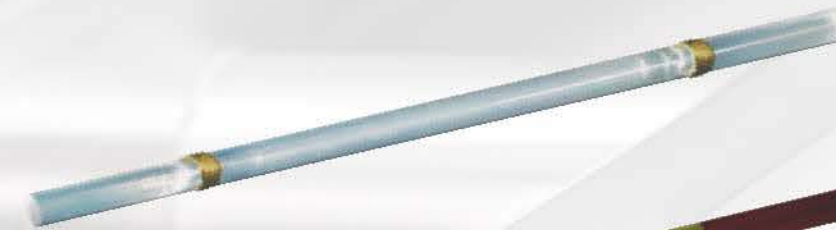

OT-H11



OT-H12



OT-H13

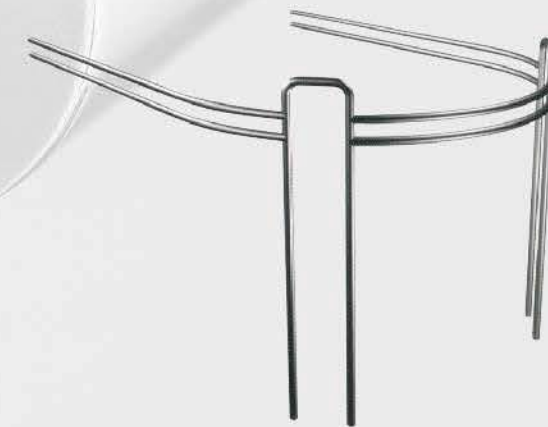

OT-H14

HOSPITAL ELEVATOR

Apex VT Systems Supplies hospital elevators that are not only used to convey the passengers. It has been put with the special and strict requirements because of its special use, function and performance. Our hospital elevators can accurately control the lift running speed with smooth and comfortable operation.

Our hospital elevator lays stress on the humane design. It fully optimizes the car structure and satisfies the customer's using demands to the maximum extent. It provides the passengers with a quiet and elegant space.



Safe And Reliable

We use the core technology of permanent magnet synchronous and gearless products for all elevators.

The extremely low rotating speed can ensure the long and reliable elevator travel.

Smooth And Secure

As our gearless traction machine drive can always keep the safe and smooth travel in heavy load, we can utilize the advanced and well-developed positioning technology, accurate leveling accuracy to more safely and conveniently transport the patients and disabled.



OT-B01

Car wall: Hairline stainless steel
Ceiling: Hairline stainless steel, LED flat lighting
Handrail: Double flat stainless steel
Floor: PVC

OT-B02

Car wall: Painted steel
Ceiling: Painted steel, LED flat lighting
Handrail: Flat stainless steel
Floor: PVC/Marble/Steel Plate



FREIGHT ELEVATOR

Following the continuous up-extension of the living space, freight elevator shoulders the responsibility of good transport. Our freight elevator applies the advanced technology, solid and firm materials. Therefore the elevator travel can adapt to various awful environments to ensure the safe, smooth and prompt up/down transport of the goods.

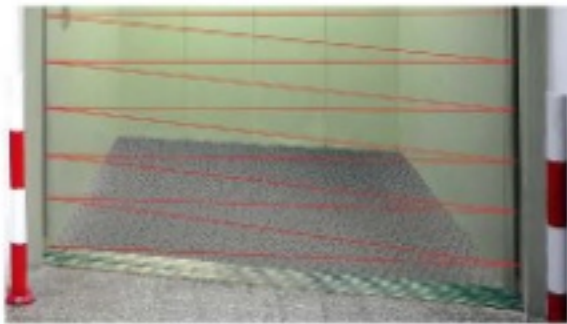

Light Curtain Protection

It forms a light curtain protection screen in the elevator entry and sensitively reacts to any object that enters into the probing range. In this way, it efficiently protects the safety of both the passengers and the freight.



High-strength Materials

Our freight elevator does not apply high-intensity section materials to manufacture the cars but also implements special reinforcement design to the car platform. It brings about the more durable and anti-ageing products.

The Multiple Door Opening Modes

In order to satisfy different entry/exit requirements from vast users, our freight elevator offers four door opening modes of side opening, center opening double-folded door, one-way door opening, opposite door opening. It can flexibly match with the factory, warehouse, department store, shopping center, housing property management center etc.



Two panel sliding door



Center-opening & double-folded type



Single way door



Double way door



OT-F01

Car ceiling: Painted steel plate (with optional colors)
Car wall: Painted steel plate (with optional colors)

Car door: Painted steel plate (with optional colors)
Lighting: Energy-saving fluorescent lamp
Floor: Checkered steel plate



OT-F02

Car ceiling: Hairline stainless steel
Car wall: Hairline stainless steel

Car door: Hairline stainless steel
Lighting: Energy-saving fluorescent lamp
Floor: Checkered steel plate



CAR ELEVATOR

The ultra high and large entry space: The world advanced technology is adopted. According to the special requirements of car in the space and performance, the super wide lift car for 2.4 meters super large depth of space for 6 meters are designed specially with higher flexibility, reliability, good convenience for various kinds of cars parking.

The counter-weight device: Have overload protection, correctly reflecting the load information of elevator when the lift car is partially loaded and asking the users to adjust loading and improve the traction conditions of the elevator.

The dedicated circuit control and display system: A special circuit control and display system, which is convenient for the driver in the car and the driver waiting outside the car.

Safety guiding device: The floor in the lift car has safety guiding device to ensure the safety of elevator and car.

The Advantageous Features



Dual operation buttons box



Special display system



Security guiding device



Operable front and back door

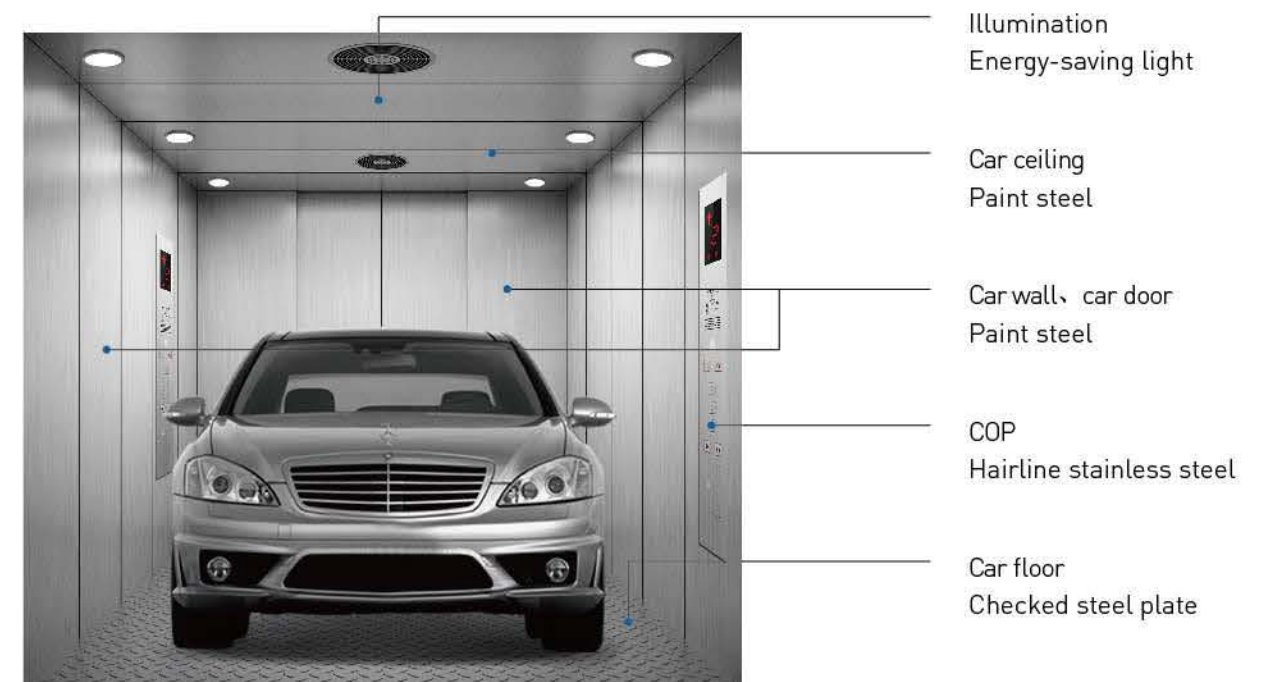



ESCALATOR

All escalator series of products seize tightly trend of time, inherit idea of safety, energy conservation and design to take details as soul of product, pursue perfection in each procedure, and share with the world with unique technology.

Different from superficial technical requirements as to escalator of other brands, our escalators are specialized more on core demands of passengers including silence technology, research and development of steady technology for your comfortable escalator taking experience.

MOVING WALK

All moving walk adopts internationally advanced technology and design idea for manufacturing with features like balanced operation, low noise, long service life, and convenient maintenance and so on. Its exquisite structure, excellent stairs, delicate belts, and luxurious appearance provide for passengers with comfortable and fashionable feeling, experiencing outstanding charm of travelling with superior quality.

